

Item code :

**VOLTA 5008**  
**(DEFENDER)**

Children's electric toy car installation and  
operating manual electric toy car

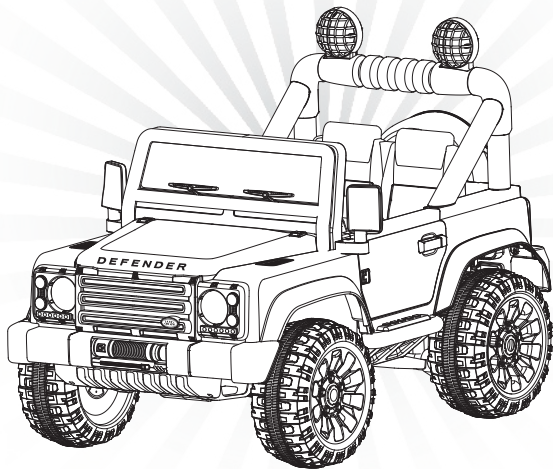

## ***Manual Instructions***

Pictures are only for reference.  
Please read this book before installation and operation.  
after reading, please keep this book for later using.







Table of contents . . . . .	01
Instructions . . . . .	02
Safe way of charging the battery. . . . .	03
Parts diagram. . . . .	04
Component diagrama . . . . .	05
Installation steps. . . . .	06
How to operate a vehicle. . . . .	08
How to recharge the vehicle. . . . .	09
Maintenance For Your Vehicle . . . . .	09
Troubleshooting & Solutions Guide . . . . .	09
Battery disposal. . . . .	11
How to use the remote control . . . . .	12
Warranty . . . . .	13

Thank you for choosing our vehicle. Each part of the vehicle is designed using a unique model

As a vehicle that is imitated in a real and unique way, which can bring fun and different feelings to your children

<b>Suitable for ages</b>	<b>37 - 96 months</b>	<b>Load capacity</b>	<b>&lt; 35 Kg</b>
<b>Speed</b>	<b>3,5 - 4,5 KM/H</b>	<b>Vehicle size</b>	<b>121 X 74 X 84 cm</b>
<b>Charger</b>	<b>In : 110V - 240, 50/60 Hz Out : DC 12V 1000 mah</b>	<b>Battery versi</b>	<b>12 V 7 AH</b>
<b>Power</b>	<b>Recharging type</b>	<b>Charging time</b>	<b>8 - 12 hour</b>
<b>Fuse</b>	<b>15 A</b>	<b>Average battery life</b>	<b>6 - 12 months</b>

**Read carefully and follow all directions** **WARNING****! BE CAREFUL****Assembly / Use :**

-  The product requires an adult to assemble. Children can be injured by small parts Sharp edges and sharp parts on assembled vehicles
  -  Be careful when opening or assembling a vehicle, children should not handle parts or help assemble the vehicle
  -  Always handle protective materials and polybags properly before assembling. children are prohibited from playing because it is dangerous
  -  Suitable for children aged 37 - 96 months, and the maximum weight of use is 35 kg
  -  Choking hazard to small parts, this product is prohibited for children under 3 years
- Direct adult supervision is required.** Don't leave your child unattended. always supervise the child while in the vehicle. Teach appropriate safety rules to your child before operating this vehicle. this rule must be applied to other players who wish to drive this vehicle. Make sure children know and monitor the safety rules for driving :
- Always wear footwear
  - Always sit in place
  - Always wear a helmet while driving
  - Only 1 driver while playing
- Keep children from unsafe driving, areas
- A. large road / alley
  -  B. Incline / sloping surfaces / pools
  - C. Only for outdoors. Generally flat surface / playground / paved park

 Do not play in the dark. Children can pass through obstacles Unexpected and be injured. Use during the day or in the light areas

 Adult should check and maintain that all components are in good condition

 To avoid damage to the motors and gears, stop the vehicle before changing from forward to reverse.











 Please select "O" when not driving. turn off the power switch. (Warning: this button only to control the driving section)

 Do not allow other children to touch the wheel when the vehicle is moving.







 These vehicles are equipped with seat belts, please teach children how buckle before use.

 Do not exceed the maximum capacity of 35 kg.

**Battery / Charger / Alkaline Batteries:**

-  Battery / charger / alkaline batteries are not toys.
-  Do not recharge a non-rechargeable battery.
-  Do not mix old batteries and new batteries or batteries of the type different alkaline standard (carbon-zinc) or rechargeable batteries (nickel-cadmium).
-  Remove The rechargeable battery from the vehicle before recharging.
-  Remove the battery when not in use for a long period of time.
-  Do not create a short circuit in the battery terminals.
-  Do not use rechargeable batteries and chargers from other products. This Could cause overheating, fire, or explode.
-  Do not open the battery and charger.
-  Do not charge the battery in reverse.
-  Battery care, Always keep dry.

**Charger:**

-  Recharge 4-6 hours before the first use, but do not recharge more than 10 hours.
-  Only adults should handle or recharge the batteries. Do not let children do recharging
-  When the vehicle speed becomes slow recharge the battery for 8-12 hours, do not recharge the battery for more than 18 hours.
-  Separate batteries, chargers and connectors to avoid shortage every time you charge the battery. If damaged or overused do not use the charger until you have replaced the missing or damaged batteries and parts.
-  Recharge the batteries in a dry place.
-  Recharge the battery at least once a month, even if the vehicle not used.

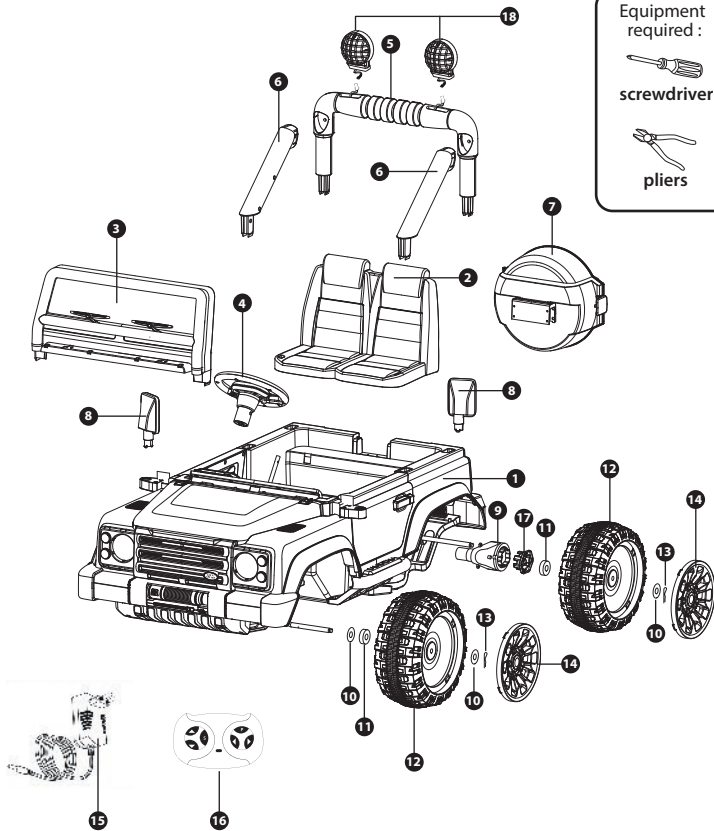

Riding vehicles will provide a comfortable driving experience.  
To help ensure that you and your driver drive safely, We ask that you read this manual carefully and save it for later reference.

Follow the recommendations in this manual, which are made for safety and the operation of your riding vehicle

1	Vehicle Body	10	Ring plat
2	Seat	11	Ring wheel
3	Windshield frames	12	Wheel
4	Steering wheel	13	Cutter pin
5	Lamp frame	14	Velg
6	Pole framework	15	Charger
7	Trunk	16	Remote
8	Rear-view mirror	17	Extensions wheel
9	Gearbox	18	Spotlights

Pay attention and follow the installation instructions below :

### Front wheel installation

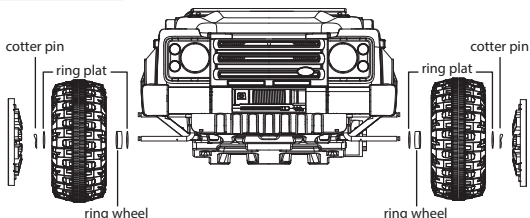

Insert the plate ring on the axle, insert the ring wheel into the wheel then insert the wheel into the axle, add the plate ring to the axle then lock it with a cutter pin, cover it with the wheel in a way pressed against the wheel until it locks.

### Rear wheel installation

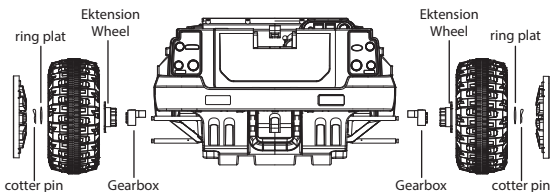

Insert the wheel into the axle, add the plate ring to the axle then lock it with a cutter pin, cover it with the wheel by pressing it against the wheel until it locks.

### Steering wheel & seat installation

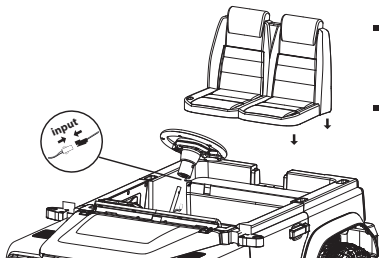

- Put the steering wheel on the steering wheel axle then connect the steering wheel socket to the locked body using nuts and bolts.
- After the steering wheel is installed, position the vehicle seat on the body correctly and then locked it with the screw.

Pay attention and follow the installation instructions below :

### Installation of windshield, mirrors & box

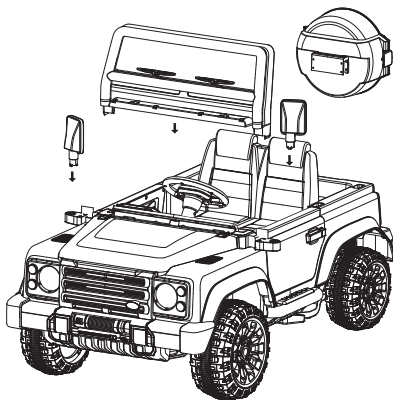

- Put the rearview mirror in the holder on the body then it locked.
- Position the windshield on the vehicle body correctly then press until it locks tightly with screws.
- Position the trunk on the vehicle body correctly then press until it locked

### Spotlight frame installation

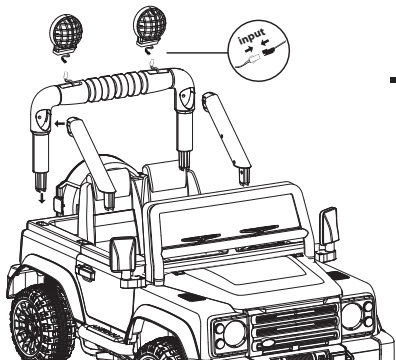

- put the pole framework to the lamp frame then press it untill locked. connect the spotlight socket then press untill it locked



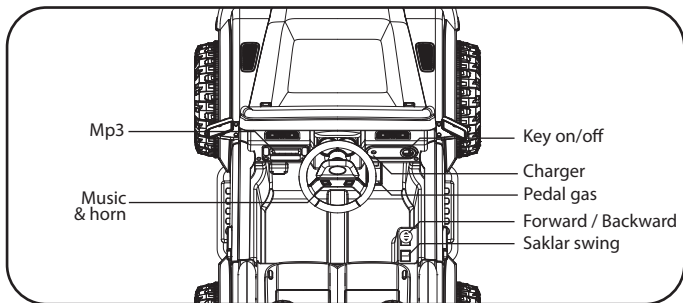

Power button, forward / reverse button, manual RC button, speed button high / low on the instrument platform.

Power button: Press the power button to unlock and it will turn off if pressed again

Manual switch: Forward

1. Push the forward switch
2. Step on the pedal, the vehicle will move forward

Backward

1. Push the switch reverse
2. Step on the pedal, the vehicle will move backward

Remote controller :      1. Press the RC button  
    2. Then an adult can adjust the direction of the vehicle  
    Speed button, fast / slow

1. Press the fast / slow speed button to get fast speed / slow speed
2. Press forward / reverse button for forward / reverse position. step on the pedal, the vehicle will move forward or backward at fast / slow speed. When using the remote control, press the speed button to adjust the speed.

For children's safety, parents have to make sure their children are have good driving ability at high speed

**Music**      Press the music button, the music will turn on. If not pressed back, then music will stop automatically

**Mp3**      Press the mode button on Mp3 (3-5 seconds), then activate bluetooth on cellphone



Don't put your ear too close, could cause hearing damage

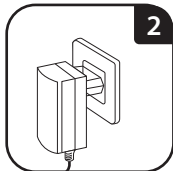
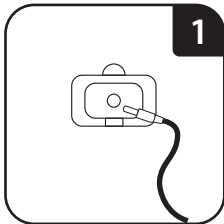
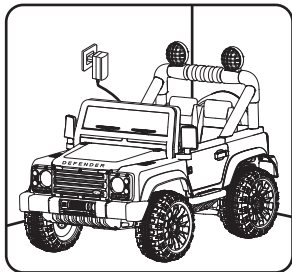

1. The vehicle charging input socket is under the front of the seat, plug the charger port into the input socket
2. Plug the charger plug into the wall outlet as shown.
3. After 8 - 12 hours fully charged, unplug the charger plug from the wall outlet and unplug the charger port from the input socket on the vehicle

### **Maintenance For Your Vehicle**

1. The vehicle material is made of polypropylene. use exposed to light direct sun or temperatures of  $-15\text{ C}$  are strictly prohibited. Vehicles must be kept away from hot objects, such as ovens and heaters, the plastic parts can melt.
2. Avoid operating the vehicle in wet or snowy conditions, and don't spray the vehicle with a hose. Do not wash the vehicle with soap and water. Water or moisture on the motor or electric switch can corrodes and can cause buttons or motors to be damaged
3. Avoid operating the vehicle on sand, dirt or gravel, because it can causes the button or motor to fail.
4. The vehicle can be cleaned with a soft, dry cloth for good results
5. Do not modify the electrical system, when errors are found it must be addressed by professionals. Changes can cause fire resulting in injury serious and can damage the electrical system
6. Use for half a month, check whether the wheel rotates properly or not. Use lubricant to lubricate moving parts.

### **Troubleshooting & Solutions Guide**

**Problem:** Vehicles cannot run

- Cause: The battery might not have any power after use and at least once a month, recharge the battery for 8-12 hours, **Don't charge for more than 18 hours**

Cause: The terminal fuse was dropped. The vehicle is equipped with a restart system self-fusing when the vehicle is overloaded or in improper use correct, the system restart the fuse itself will disconnect for 2 minutes before it can operate again. The fuse restart system itself is located under the seat.

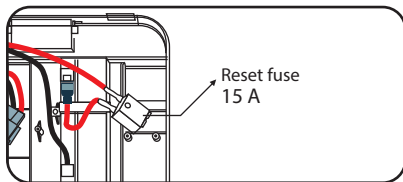

- Cause: The connector or connector cable was loose  
make sure the battery connectors are securely attached to each other
- Cause: the battery is dead  
please contact the distributor
- Cause: The rusank electrical system  
please contact the developer or factory
- Cause: The motor is damaged  
needs professional repair. Please contact the distributor

Problem: The battery cannot be recharged

- Cause: The battery connector or adapter connector was loose  
make sure the battery connector and adapter are seated together properly
- Cause: the charger is not plugged in  
make sure the charger is plugged into the wall socket and confirm the power on the socket is on
- Cause: The charger was not working  
Does Charger feel warm when recharging? if not, the charger may be damaged and please call distributor  
Problem: the vehicle cannot run for long

Cause: the battery might need to be recharged

- You may not have recharged the battery for a long time.  
After each use, or at least once a month, recharge the battery for 8-12 hours. Do not recharge for more than 18 hours



Don't throw it in the fire. Batteries may explode or leak

Batteries with a lead acid seal must be recycled or disposed of in an environmentally friendly place

### **Warning :**

1. This product is not a means of transportation, do not drive on the road, use this product under adult supervision.
2. Do not allow children under 36 months to use this product.
3. Overload is not allowed. maximum load 35 kg
4. The vehicle must be assembled and inspected by an adult,
5. Do not wash the product with water, wipe only with use a soft, damp cloth
6. Recharging the battery must be done by an adult, don't let children charge battery.
7. Driving is prohibited on public roads, downhill roads, pool sides, head of stairs and other dangerous areas.
8. Please read carefully and keep the user manual for your child's safety.
9. To prevent children from shortness of breath, keep the plastic from children
10. Only adults may operate the remote control, and keep a distance of up to 10 m for the remote controller and the vehicle.

### Only adults may use the remote control

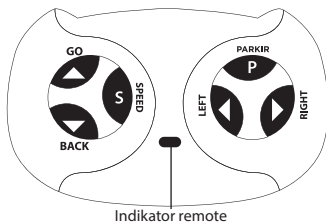

#### 2.4G Remote control instructions

Step 1: The remote controller is loaded with AAA batteries

Step 2: Turn off the power switch on the vehicle.

Step 3: Hold down "▲" & "▼" keys for 3 seconds start match code, the first LED flicker, now turn on vehicle power switch the red indicator light stop flashing and the code is successful.

key caption: "S" set up speed, 1 led lit up is low speed, 2 leds lit up is medium speed, 3 leds lit up is high speed, "▲" forward, "▼" back, "◀" left, "▶" right, press "P" key hold the brake, ALL LED flicker

**Instructions:** The vehicle is designed to operate at low speed only in reverse let the remote controller stop for 10 seconds it will turn off automatically repeat step 1 when you replace the remote controller battery

## Limited Warranty

### General:

- Part or model specifications are subject to change without notice.
- This Limited Warranty is the only warranty for the product. There are no other express warranties.
- The only uses for this product are described in this manual.
- Warranty registration is not required.
- The Limited Warranty extends only to the original consumer and is not transferable to anyone else.

### What does this Limited Warranty cover?

This Limited Warranty covers all parts of the product except those indicated below as not warranted.

### What must you do to keep the Limited Warranty in effect?

This Limited Warranty is effective only if:

- Product is completely and correctly assembled.
- Product is used under normal conditions for its intended purpose (see the following section for excluded activities).
- Product receives all necessary maintenance and adjustments.
- Product is used for general transportation and recreational use only.

### What is not covered by this Limited Warranty?

This product is designed for recreational use only. This Limited Warranty does not cover normal wear and tear, normal maintenance items, or any damage, failure, or loss that is caused by improper assembly, maintenance, adjustment, storage, or use of the product.

### This Limited Warranty will be void if the product is ever:

- Used in any competitive sport
- Used for stunt riding, jumping, aerobatics or similar activity
- Modified in any way
- Modified with the addition of a motor
- Ridden by more than one person at a time
- Rented, sold, or given away
- Used in a manner contrary to the instructions and warnings in this Owner's Manual

### How do you get service?

Contact the Customer Service Department.

Email- [enquiries@idealsources.com.au](mailto:enquiries@idealsources.com.au)

Website- [www.idealsources.com.au](http://www.idealsources.com.au)



Land Rover and Land Rover Logo are trademarks  
owned and licensed by **Jaguar Land Rover Limited**.  
*Licensee: Pinghu Tongsheng Trading Co., Ltd.*

Produced by **PT.Sinar Harapan Plastik**  
Imported by **IDEAL SOURCES**

**Made in Indonesia**  
[www.shptoys.com](http://www.shptoys.com)