

English

329
AU

IMPORTANT SAFETY RULES

Please read, understand, and follow all instructions carefully before installing and using this product. Keep for future reference.

Saltwater System

Model ECO5220/6220 220 - 230 V~

Model ECO5230/6230 230 - 240 V~



For illustrative purposes only.

Don't forget to try these other fine Intex products: pools, pool accessories, inflatable pools and in-home toys, airbeds and boats available at fine retailers or visit our website.

Due to a policy of continuous product improvement, Intex reserves the right to change specifications and appearance, which may result in updates to the instruction manual without notice.



©2018 Intex Marketing Ltd. - Intex Development Co. Ltd. - Intex Recreation Corp.
All rights reserved/Tous droits réservés/Todos los derechos reservados/Alle Rechte vorbehalten. Printed in China/Imprimé en Chine/Impreso en China/ Gedruckt in China.

®™ Trademarks used in some countries of the world under license from/®™ Marques utilisées dans certains pays sous licence de/Marcas registradas utilizadas en algunos países del mundo bajo licencia de/Warenzeichen verwendet in einigen Ländern der Welt in Lizenz von/Intex Marketing Ltd. to/à/a/an Intex Development Co. Ltd., G.P.O Box 28829, Hong Kong & Intex Recreation Corp., P.O. Box 1440, Long Beach, CA 90801 • Distributed in the European Union by/Distribué dans l'Union Européenne par/Distribuido en la unión Europea por/Vertrieb in der Europäischen Union durch/Intex Trading B.V., Venneveld 9, 4705 RR Roosendaal – The Netherlands
www.intexcorp.com

OWNER'S MANUAL

TABLE OF CONTENTS

Warnings.....	3
Parts References.....	4
Product Information & Specifications.....	5
Setup Instructions.....	6-10
Salt & Pool Water Volumes.....	11
Intex Pools Salt Table.....	12
Intex Pools Cyanuric Acid Table.....	13
Intex Pools Operating Time Table.....	14
Non-Intex Pools Salt Table.....	15
Non-Intex Pools Cyanuric Acid Table.....	15
Non-Intex Pools Operating Time Table.....	15
Operating Instructions.....	16-18
LED Code Chart.....	19
Stationary Mounting.....	20
Maintenance.....	21-23
Long Term Storage.....	23
Pool Maintenance and Chemical Definitions.....	24
Troubleshooting Guide.....	25-26
Control Station Replacement.....	27
General Aquatic Safety.....	27
Limited Warranty.....	28

IMPORTANT SAFETY RULES

Read, Understand and Follow All Instructions Carefully Before Installing and Using this Product.

READ AND FOLLOW ALL INSTRUCTIONS

WARNING

- Always supervise children and those with disabilities.
- Children must stay away from this product and electrical cord(s).
- Children shall not play with the appliance. Cleaning and maintenance must be performed by an adult above 18 years old, and who is familiar with the risk of electric shock.
- This appliance can be used by children aged from 8 years and above and persons with reduced physical, sensory or mental capabilities or lack of experience and knowledge if they have been given supervision or instruction concerning use of the appliance in a safe way and understand the hazards involved.
- Assembly and disassembly by adults only.
- The pump must be supplied through a residual current device(RCD) having a rated residual operating current not exceeding 30mA.
- Always unplug this product from the electrical outlet before removing, cleaning, servicing or making any adjustment to the product.
- Do not bury the electrical cord. Locate the cord where it will not be damaged by lawn mowers, hedge trimmers and other equipment.
- The supply cord cannot be replaced. If the cord is damaged the appliance should be scrapped.
- To reduce the risk of electric shock, do not use extension cords, timers, plug adaptors or converter plugs to connect unit to electric supply; provide a properly located outlet.
- Do not attempt to plug in or unplug this product while standing in water or when your hands are wet.
- Keep this product more than 2m away from the pool.
- Keep the plug of this product more than 3.5m away from the pool.
- Position this product away from the pool, so as to prevent children from climbing on it and accessing the pool.
- The pump must not be used when people are in the water.
- This product is for use with storable pools only. Do not use with permanently installed pools. A storable pool is constructed so that it may be readily disassembled for storage and reassembled to its original configuration.
- The appliance is intended only for household use.
- This product is intended to be used only for the purposes described in the manual!

FAILURE TO FOLLOW THESE WARNINGS MAY RESULT IN PROPERTY DAMAGE, ELECTRIC SHOCK, ENTANGLEMENT OR OTHER SERIOUS INJURY OR DEATH.

These product warnings, instructions and safety rules provided with the product represent some common risks of water recreation devices and do not cover all instances of risk and danger. Please use common sense and good judgement when enjoying any water activity.

For portable Above-Ground-Pools only

PARTS REFERENCE

Before assembling your product, please take a few minutes to check the contents and become familiar with all the parts.

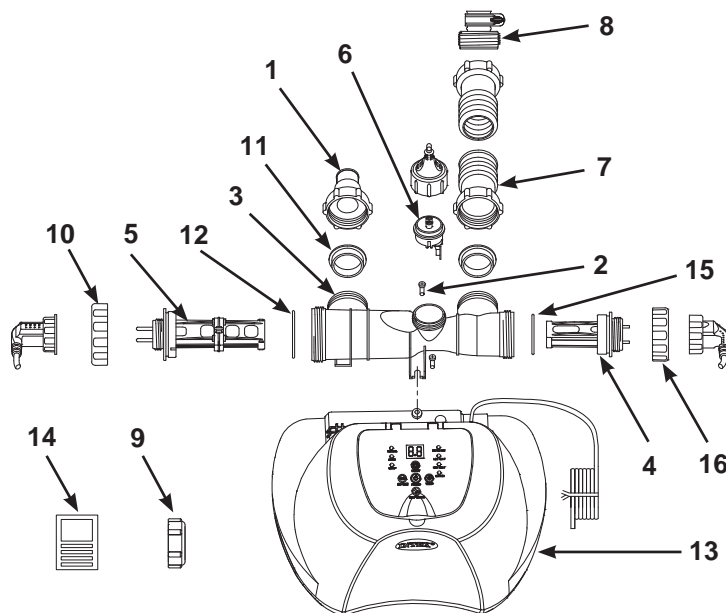

NOTE: Drawings for illustration purpose only. Actual product may vary. Not to scale.

REF. NO.		DESCRIPTION	QTY.	SPARE PART NO.	
COMMON PARTS	PARTS FOR CONNECTION TO FILTER PUMPS WITH 1-1/4" (32MM) HOSE SIZE			ECO5220/5230	ECO6220/6230
	1	ADAPTOR A WITH THREADED COLLAR (OPTIONAL)	1	10849	10849
	2	SCREW	2	11519	11519
	3	ELECTROLYTIC CELL HOUSING	1	11898	11903
	4	SECONDARY ELECTROLYTIC CELL	1	11900	11905
	5	PRIMARY ELECTROLYTIC CELL	1	11899	11904
	6	FLOW SENSOR	1	11460	11460
	7	CONNECTOR HOSE WITH THREADED FITTINGS	1	10720	10720
	8	THREADED ADAPTOR B (OPTIONAL)	1	10722	10722
	9	CELL COVER	2	11131	11131
	10	ELECTROLYTIC CELL NUT	1	11582	11432
	11	L-SHAPE O-RING	2	11228	11228
	12	TITANIUM ELECTRODE O-RING	1	11585	11515
	13	CONTROL STATION	1	12658AU	12660AU
	14	TEST STRIPS	1	19635	19635
	15	TITANIUM ELECTRODE O-RING	1	11585	11585
	16	ELECTROLYTIC CELL NUT	1	11582	11582

When ordering parts, be sure to quote the model number and part numbers.

HOW THE CHLORINE IS GENERATED

This product is specially designed for above ground pools. It will destroy the bacteria, oxidize bather organics and control algae, which provide a safe, clean and comfortable swimming pool.

Common salt (sodium chloride) is made up of two elements, sodium and chloride. During the installation of your Saltwater System, a measured quantity of salt is dissolved in the pool water to make it slightly salty. The pool water flows through the Saltwater System's electrolytic cell (5) to produce chlorine. The chlorine dissolves in the water and instantly starts destroying bacteria and algae. It also oxidizes all other organic materials.

The secondary electrolytic cell boosts the chlorination and sanitizing power for additional oxidation of water contaminants.

PRODUCT SPECIFICATIONS

Model:	ECO5220/5230	ECO6220/6230
Wattage:	65 W	125 W
Ideal Salt Level:	3000 ppm (parts per million)	3000 ppm (parts per million)
Secondary Cell Output Current:	500 mA	800 mA
Maximum Chlorine Output/hour:	5 grams/hour	12 grams/hour
Filter pump minimum flow rate:	700 ~ 3000 gallons/hour (2650 - 11355 liters/hour)	700 ~ 3000 gallons/hour (2650 - 11355 liters/hour)
Limited Warranty:	see "Limited Warranty"	

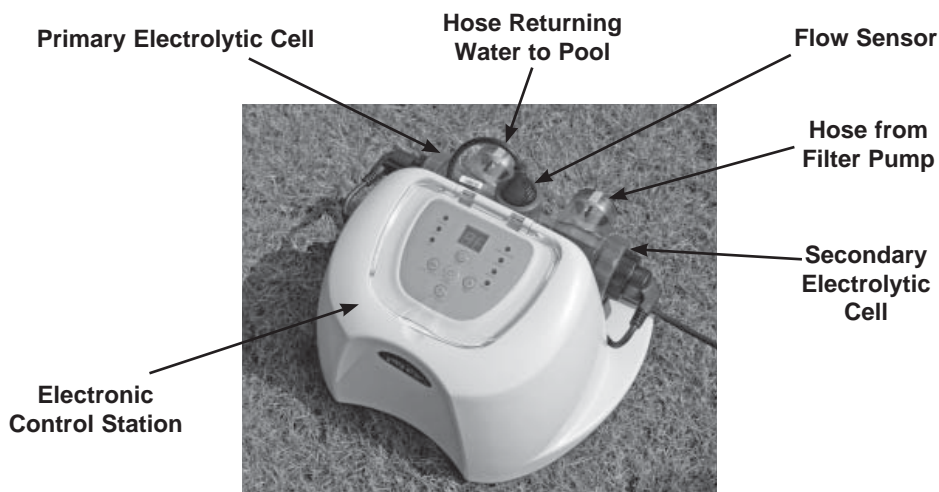

No tools are required for the assembly.

SETUP INSTRUCTIONS

IMPORTANT

- The Saltwater System requires a separate filter pump [700~3000 gph (2650~11355 lph)] to drive the water and function properly.
- The Saltwater System must be installed as the last piece of pool equipment in the water return line to the pool as displayed in Drawing #1. This location extends the life of the titanium plates.

1. Assemble the above-ground-pool (AGP) and its filter pump according to their installation instructions.
2. Take the Saltwater System and its accessories out of the packaging.
3. Place the Saltwater System in line after the filter pump.
4. Connect the connector hose (7) to the Saltwater System inlet.

Connecting the system to pump and pool with 1-1/4" (32mm) connections/hoses:
 The saltwater system features 1-1/2" (38mm) connections. It is accordingly supplied with adaptors A (1) and B (8) for connecting to the small 1-1/4" (32mm) diameter connections/hoses. Install as follows:

Drawing #1

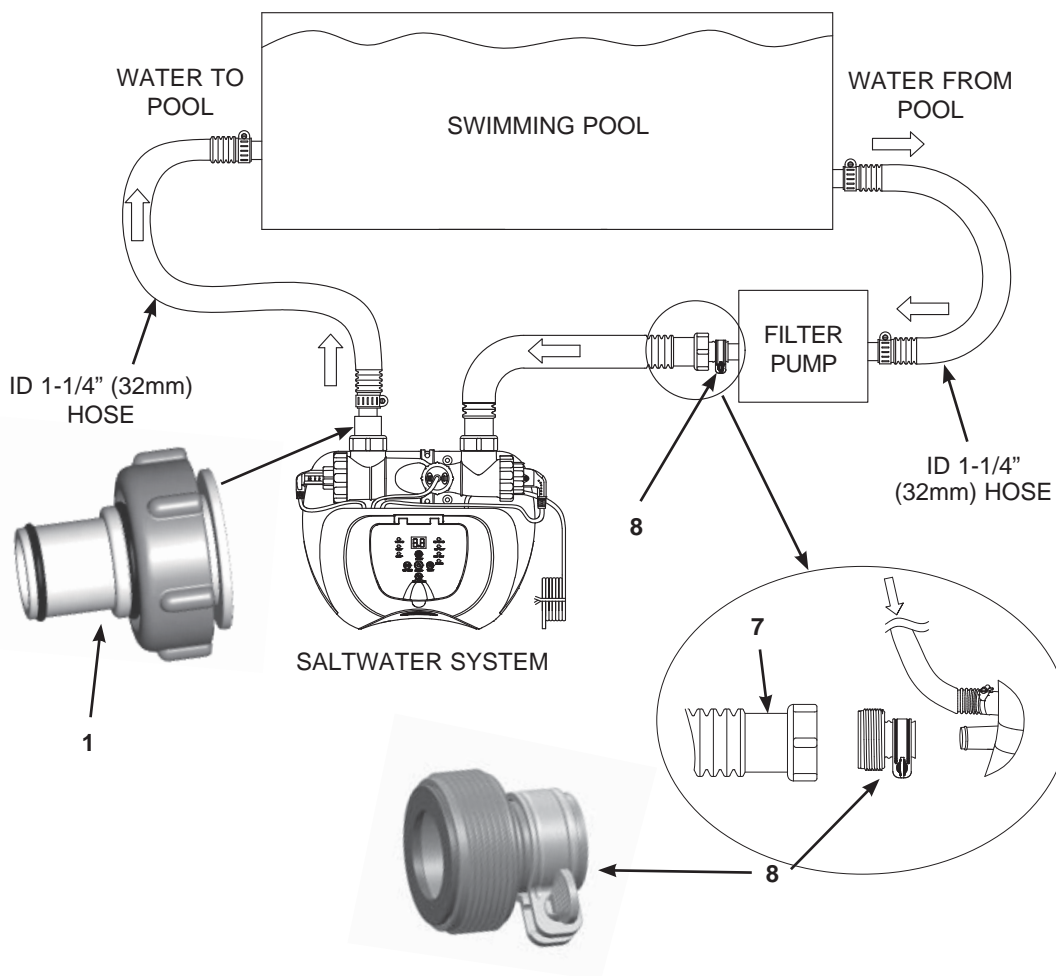

SETUP INSTRUCTIONS (continued)

1. Go directly to step 2 if your pool is empty. If your above-ground-pool is filled with water, unscrew the strainer grids from the strainer connectors and insert the black hat-like plugs into the connectors, before installing the saltwater pool system.
2. Connect the adaptor A (1) to the electrolytic cell (3) outlet as shown in Drawing #1. Tighten securely.

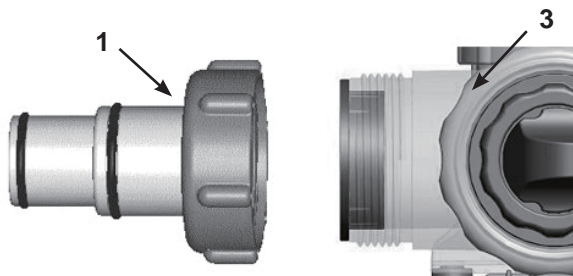

3. Disconnect the water return hose from the filter pump connection and connect it to the adaptor A (1) on the Saltwater System with a hose clamp. (see Drawing #1)
4. Connect adaptor B (8) to the connector hose (7). Tighten securely. (see Drawing #1)

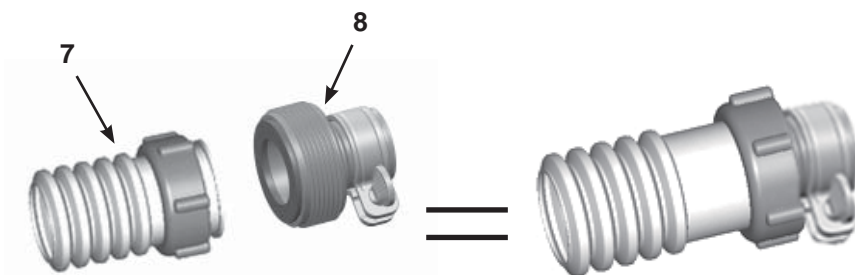

5. Connect adaptor B (8) to filter pump outlet (lower connection). Tighten securely.

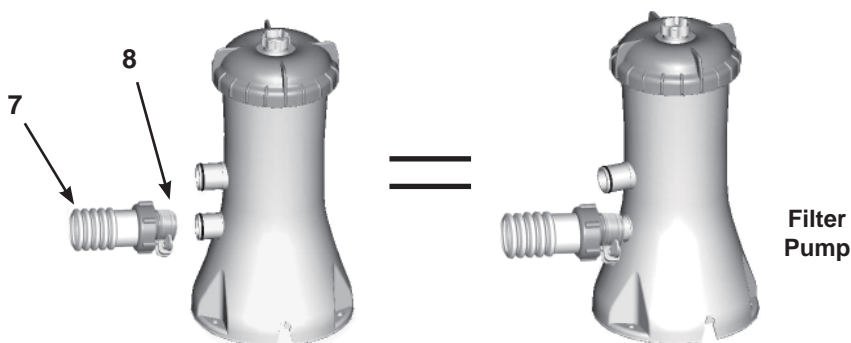

6. Remove the black hat-like plugs that prevent water from flowing out of the pool. Now, return the strainer grids to the strainer connectors.

SETUP INSTRUCTIONS (continued)

Connecting the system to pump and pool with 1-1/2" (38mm) connections/hoses:
Pump and pool with 1-1/2" (38mm) connections do not require the adaptors A (1) or B (8).
Install as follows:

Drawing #2

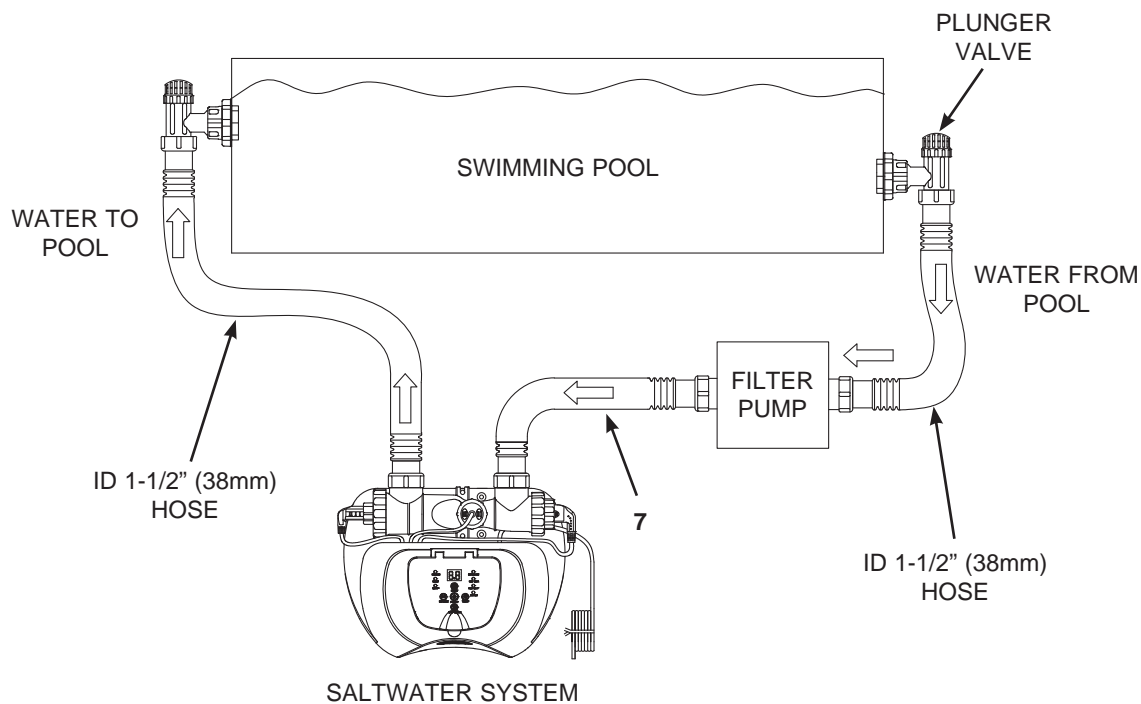

1. Go directly to step 2 if your pool is empty. If your above-ground-pool is filled with water, close the plunger valves before installing the Saltwater System.
2. Disconnect the water return hose from the filter pump connection and connect it to the Saltwater System outlet.
3. Connect the connector hose (**7**) to the filter pump outlet connection.
4. Open the plunger valves to allow the water to flow.

SETUP INSTRUCTIONS (continued)

Connecting the system to other types of pump (with different type of thread or no thread):

The Saltwater System can also be adapted to other filter pumps with different thread or those without a thread on the connection.

Connection to 1-1/4" (32mm) hose:

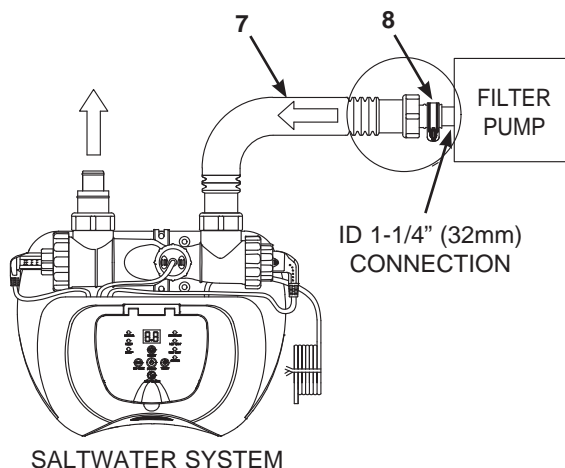

1. Connect one end of adaptor B (8) to the connector hose (7). Tighten securely.
2. Now, connect the other end of adaptor B (8) to the filter pump outlet. Tighten securely.

Connection to 1-1/2" (38mm) hose with clamp:

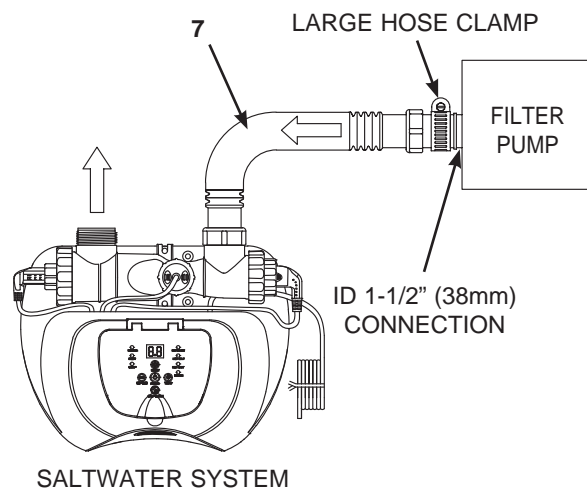

1. Connect the connector hose (7) to the filter pump outlet connection with a large hose clamp. Tighten securely.

SETUP INSTRUCTIONS (continued)

Connecting the system to other types of pool

After you have connected the Saltwater System to the pump, connect it to the pool. This is depicted in Drawings #1 and #2.

Following are the common connection types:

Connection to 1-1/4" (32mm) connectors:

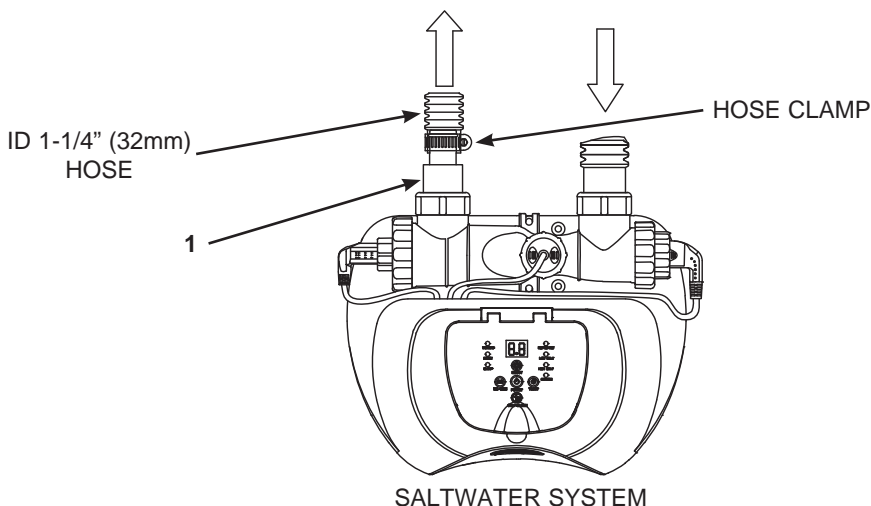

1. Connect the adaptor A (1) to the electrolytic cell (3) outlet. Tighten securely.
2. The adapter A (1) is now fitted to the Saltwater System. The following step is to connect the water return hose to the adaptor A (1) with a hose clamp.

Connection to 1-1/2" (38mm) connectors without thread:

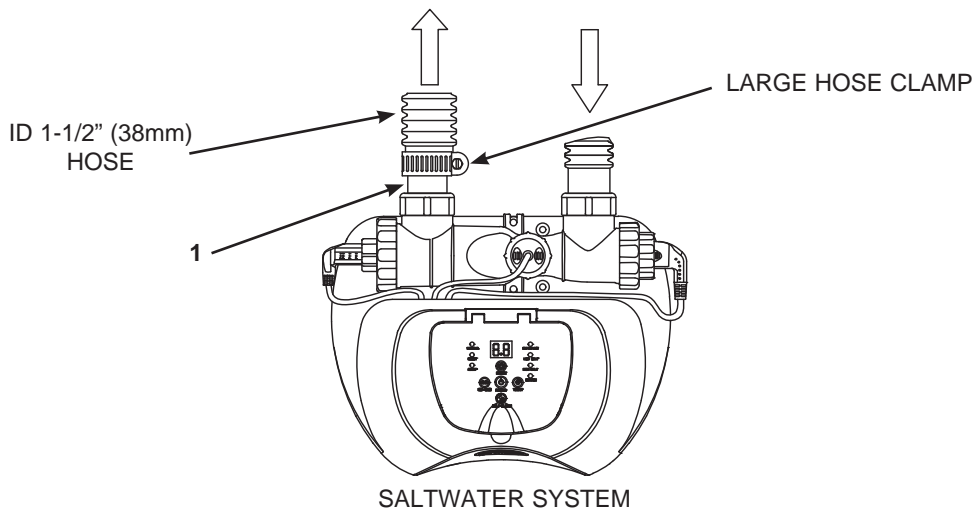

1. Connect the adaptor A (1) to the electrolytic cell (3) outlet. Tighten securely.
2. With the adaptor A (1) fixed to the Saltwater System, connect the water return hose to the adaptor, using a large hose clamp.

SALT & POOL WATER VOLUMES

• Which kind of salt to use:

For use within the European Union, salt must be from an authorized salt supplier registered with the European Chemicals Agency (ECHA) - visit echa.europa.eu. *

Use only Sodium Chloride Salts

Use only sodium chloride (NaCl) salt that is at least 99.8% pure. It is also acceptable to use water conditioning salt pellets (the compressed forms of evaporated salt). However, it will take a longer time for them to dissolve. **Do not use iodized or yellow (yellow prussiate of soda) colored salt.** Salt is added to the pool water and the electrolytic cell uses the salt to create chlorine. The purer the salt the better the performance of the electrolytic cell.

• Optimum Salt Levels

The ideal salt level in the pool water is between 2500-3500 ppm (parts per million). The optimal level is 3000 ppm.

A too low salt level will reduce the efficiency of the Saltwater System and result in low chlorine production. A high salt level may generate a salty taste to the pool water (this may occur at a salt level above 3500-4000ppm). Too high a salt level may damage the power supply and cause corrosion to the pool metal fixtures and accessories. The Salt Table page of this manual, shows the correct dosage of salt needed. The salt in the pool is constantly recycled. The loss of salt is due only to pool water being physically removed from the pool. Salt is not lost due to evaporation.

• Adding Salt

1. Switch the filter pump on to start the water circulation.
2. Keep the Saltwater System turned off.
3. Determine the amount of salt to be added (see "Salt Table").
4. Evenly spread the proper amount of salt around the inside perimeter of the pool.
5. Avoid clogging the filter. Do not add salt through the skimmer.
6. Brush the pool bottom to speed up the dissolving process. Do not allow salt to pile up on the bottom of the pool. Run the filter pump 24 consecutive hours to thoroughly dissolve the salt.
7. After 24 hours and if all the salt is dissolved, turn on the Saltwater System, press  button until you hear a "beep", code "00" flashing and set the saltwater pool system to desired operating time (see "Operating Time Table").

• Removing Salt

If too much salt has been added, the unit will beep and display "Code 92" (see "Alarm Codes"). You will need to lower the salt concentration. The only way to do so, is to partially drain the pool and refill it with fresh water. Drain and refill approximately 20% of the pool's water until the "Code 92" disappears.

• Pool Volume Calculation

Types of Pool	Gallons (pool size in feet)	Cubic Meters (pool size in meters)
Rectangular	Length x Width x Average Depth x 7.5	Length x Width x Average Depth
Circular	Length x Width x Average Depth x 5.9	Length x Width x Average Depth x 0.79
Oval	Length x Width x Average Depth x 6.0	Length x Width x Average Depth x 0.80

* The European Biocidal Products Regulation (BPR, Regulation (EU) 528/2012) requires that salt (sodium chloride) used as a precursor for on-site generation of active chlorine by electrolysis must be registered by the salt supplier with the European Chemicals Agency (ECHA), and such supplier must be included on ECHA's list of authorized suppliers (Article 95 list).

INTEX POOLS SALT TABLE

This table shows the amount of salt needed to achieve and maintain the optimal 3000 ppm salt level.

Pool Size		Water Capacity (Calculated at 90% for Frame Pool and 80% for Easy Set & Oval Pool)		Salt Needed for Startup 3.0g/L (3000ppm)		Salt Needed when Low Salt Detected (CODE "91")	
		(Gals)	(Liters)	(Lbs)	(Kgs)	(Lbs)	(Kgs)
INTEX ABOVE GROUND POOLS (AGP's)							
EASY SET® POOL	15' x 33" (457cm x 84cm)	2587	9792	65	30	20	10
	15' x 36" (457cm x 91cm)	2822	10681	65	30	20	10
	15' x 42" (457cm x 107cm)	3284	12430	80	35	20	10
	15' x 48" (457cm x 122cm)	3736	14141	95	45	25	10
	16' x 42" (488cm x 107cm)	3754	14209	95	45	25	10
	16' x 48" (488cm x 122cm)	4273	16173	110	50	30	15
	16' x 52" (488cm x 132cm)	4614	17464	115	50	30	15
	18' x 42" (549cm x 107cm)	4786	18115	120	55	30	15
18' x 48" (549cm x 122cm)	5455	20647	135	60	35	15	
CIRCULAR METAL FRAME POOL	15' x 36" (457cm x 91cm)	3282	12422	80	35	20	10
	15' x 42" (457cm x 107cm)	3861	14614	100	45	25	10
	15' x 48" (457cm x 122cm)	4440	16805	110	50	30	15
	16' x 48" (488cm x 122cm)	5061	19156	125	55	35	15
	18' x 48" (549cm x 122cm)	6423	24311	160	75	40	20
	21' x 52" (640cm x 132cm)	9533	36082	240	110	60	30
	24' x 52" (732cm x 132cm)	12481	47241	310	140	80	35
ULTRA FRAME® POOL	16' x 48" (488cm x 122cm)	5061	19156	125	55	35	15
	18' x 48" (549cm x 122cm)	6423	24311	160	75	40	20
	18' x 52" (549cm x 132cm)	6981	26423	175	80	45	20
	20' x 48" (610cm x 122cm)	7947	30079	210	90	50	25
	22' x 52" (671cm x 132cm)	10472	39637	260	120	65	30
	24' x 52" (732cm x 132cm)	12481	47241	310	140	80	35
	26' x 52" (792cm x 132cm)	14667	55515	365	165	90	40
GRAPHITE GRAY PANEL POOL SET™	15'8" x 49" (478cm x 124cm)	4440	16805	110	50	30	15
	16'8" x 49" (508cm x 124cm)	5061	19156	125	55	35	15
	18'8" x 53" (569cm x 135cm)	6981	26423	175	80	45	20
OVAL FRAME POOL	18' x 10' x 42" (549cm x 305cm x 107cm)	2885	10920	70	30	20	10
	20' x 12' x 48" (610cm x 366cm x 122cm)	4393	16628	110	50	30	15
RECT. ULTRA FRAME POOL	15' x 9' x 48" (457cm x 274cm x 122cm)	3484	13187	90	40	25	10
	18' x 9' x 52" (549cm x 274cm x 132cm)	4545	17203	115	50	30	15
	20 x 10' x 52" (610cm x 305cm x 132cm)	5835	22085	145	65	40	20
	24' x 12' x 52" (732cm x 366cm x 132cm)	8403	31805	210	95	55	25
	32' x 16' x 52" (975cm x 488cm x 132cm)	14364	54368	360	165	90	40

INTEX POOLS CYANURIC ACID TABLE

Cyanuric acid is a chemical that reduces the loss of chlorine in water due to ultraviolet rays. To maintain the pool water clear and clean, and to maximize the performance of the device, add cyanuric acid to the pool. We recommend that the cyanuric acid level be maintained at approximately 1% of the salt, i.e. 100 Lbs (45 Kgs) salt x1% = 1 Lbs (0.45 Kgs) cyanuric acid. If the pool water is dirty, filthy or grimy, DO NOT add chlorine stabilizer (cyanuric acid) as this will slowdown the sanitation time of the device. Under this condition you must BOOST your pool water, refer to BOOST cycle steps. Once the pool water has been restored to clear and clean conditions you may add cyanuric acid.

Pool Size		Water Capacity (Calculated at 90% for Frame Pool and 80% for Easy Set & Oval Pool)		Cyanuric Acid Needed for Startup 0.03g/L (30ppm)	
		(Gals)	(Liters)	(Lbs)	(Kgs)
INTEX ABOVE GROUND POOLS (AGP's)					
EASY SET® POOL	15' x 33" (457cm x 84cm)	2587	9792	0.6	0.3
	15' x 36" (457cm x 91cm)	2822	10681	0.7	0.3
	15' x 42" (457cm x 107cm)	3284	12430	0.8	0.4
	15' x 48" (457cm x 122cm)	3736	14141	0.9	0.4
	16' x 42" (488cm x 107cm)	3754	14209	0.9	0.4
	16' x 48" (488cm x 122cm)	4273	16173	1.1	0.5
	16' x 52" (488cm x 132cm)	4614	17464	1.2	0.5
	18' x 42" (549cm x 107cm)	4786	18115	1.2	0.5
	18' x 48" (549cm x 122cm)	5455	20647	1.4	0.6
CIRCULAR METAL FRAME POOL	15' x 36" (457cm x 91cm)	3282	12422	0.8	0.4
	15' x 42" (457cm x 107cm)	3861	14614	1.0	0.4
	15' x 48" (457cm x 122cm)	4440	16805	1.1	0.5
	16' x 48" (488cm x 122cm)	5061	19156	1.3	0.6
	18' x 48" (549cm x 122cm)	6423	24311	1.6	0.7
	21' x 52" (640cm x 132cm)	9533	36082	2.4	1.1
	24' x 52" (732cm x 132cm)	12481	47241	3.1	1.4
ULTRA FRAME® POOL	16' x 48" (488cm x 122cm)	5061	19156	1.3	0.6
	18' x 48" (549cm x 122cm)	6423	24311	1.6	0.7
	18' x 52" (549cm x 132cm)	6981	26423	1.7	0.8
	20' x 48" (610cm x 122cm)	7947	30079	2.0	0.9
	22' x 52" (671cm x 132cm)	10472	39637	2.6	1.2
	24' x 52" (732cm x 132cm)	12481	47241	3.1	1.4
	26' x 52" (792cm x 132cm)	14667	55515	3.7	1.7
GRAPHITE GRAY PANEL POOL SET™	15'8" x 49" (478cm x 124cm)	4440	16805	1.1	0.5
	16'8" x 49" (508cm x 124cm)	5061	19156	1.3	0.6
	18'8" x 53" (569cm x 135cm)	6981	26423	1.7	0.8
OVAL FRAME POOL	18' x 10' x 42" (549cm x 305cm x 107cm)	2885	10920	0.7	0.3
	20' x 12' x 48" (610cm x 366cm x 122cm)	4393	16628	1.1	0.5
RECT. ULTRA FRAME POOL	15' x 9' x 48" (457cm x 274cm x 122cm)	3484	13187	0.9	0.4
	18' x 9' x 52" (549cm x 274cm x 132cm)	4545	17203	1.1	0.5
	20' x 10' x 52" (610cm x 305cm x 132cm)	5835	22085	1.5	0.7
	24' x 12' x 52" (732cm x 366cm x 132cm)	8403	31805	2.1	1.0
	32' x 16' x 52" (975cm x 488cm x 132cm)	14364	54368	3.6	1.6

INTEX POOLS OPERATING TIME TABLE (WITH CYANURIC ACID)

Pool Size		Water Capacity (Calculated at 90% for Frame Pool and 80% for Easy Set & Oval Pool)		Operating Time (hours) at different ambient/air temperatures			Intex Filter pump Operating Time (hours)
		(Gals)	(Liters)	10 - 19°C (50 - 66°F)	20 - 28°C (68 - 82°F)	29 - 36°C (84 - 97°F)	
MODEL: ECO5220/5230							
EASY SET® POOL	15' x 33" (457cm x 84cm)	2587	9792	3	3	4	6
	15' x 36" (457cm x 91cm)	2822	10681	3	4	5	6
	15' x 42" (457cm x 107cm)	3284	12430	3	4	5	6
	15' x 48" (457cm x 122cm)	3736	14141	4	5	6	8
	16' x 42" (488cm x 107cm)	3754	14209	4	5	6	8
	16' x 48" (488cm x 122cm)	4273	16173	4	5	6	8
	16' x 52" (488cm x 132cm)	4614	17464	5	6	7	8
	18' x 42" (549cm x 107cm)	4786	18115	5	6	7	8
18' x 48" (549cm x 122cm)	5455	20647	6	7	8	12	
CIRCULAR METAL FRAME POOL	15' x 36" (457cm x 91cm)	3282	12422	3	4	5	6
	15' x 42" (457cm x 107cm)	3861	14614	4	5	6	8
	15' x 48" (457cm x 122cm)	4440	16805	5	6	6	8
	16' x 48" (488cm x 122cm)	5061	19156	5	6	7	8
	18' x 48" (549cm x 122cm)	6423	24311	7	8	9	12
	21' x 52" (640cm x 132cm)	9533	36082	-	-	-	-
	24' x 52" (732cm x 132cm)	12481	47241	-	-	-	-
ULTRA FRAME® POOL	16' x 48" (488cm x 122cm)	5061	19156	5	6	7	8
	18' x 48" (549cm x 122cm)	6423	24311	7	8	9	12
	18' x 52" (549cm x 132cm)	6981	26423	-	-	-	-
	20' x 48" (610cm x 122cm)	7947	30079	-	-	-	-
	22' x 52" (671cm x 132cm)	10472	39637	-	-	-	-
	24' x 52" (732cm x 132cm)	12481	47241	-	-	-	-
	26' x 52" (792cm x 132cm)	14667	55515	-	-	-	-
GRAPHITE GRAY PANEL POOL SET™	15'8" x 49" (478cm x 124cm)	4440	16805	5	6	6	8
	16'8" x 49" (508cm x 124cm)	5061	19156	5	6	7	8
	18'8" x 53" (569cm x 135cm)	6981	26423	-	-	-	-
OVAL FRAME POOL	18' x 10' x 42" (549cm x 305cm x 107cm)	2885	10920	3	4	5	6
	20' x 12' x 48" (610cm x 366cm x 122cm)	4393	16628	5	5	6	8
RECT. ULTRA FRAME POOL	15' x 9' x 48" (457cm x 274cm x 122cm)	3484	13187	3	4	5	6
	18' x 9' x 52" (549cm x 274cm x 132cm)	4545	17203	5	6	7	8
	20 x 10' x 52" (610cm x 305cm x 132cm)	5835	22085	6	7	8	12
	24' x 12' x 52" (732cm x 366cm x 132cm)	8403	31805	-	-	-	-
	32' x 16' x 52" (975cm x 488cm x 132cm)	14364	54368	-	-	-	-

INTEX POOLS OPERATING TIME TABLE (WITH CYANURIC ACID)

Pool Size		Water Capacity (Calculated at 90% for Frame Pool and 80% for Easy Set & Oval Pool)		Operating Time (hours) at different ambient/air temperatures			Intex Filter pump Operating Time (hours)
		(Gals)	(Liters)	10 - 19°C (50 - 66°F)	20 - 28°C (68 - 82°F)	29 - 36°C (84 - 97°F)	
MODEL: ECO6220/6230							
EASY SET® POOL	15' x 33" (457cm x 84cm)	2587	9792	1	2	3	4
	15' x 36" (457cm x 91cm)	2822	10681	1	2	3	4
	15' x 42" (457cm x 107cm)	3284	12430	1	2	3	4
	15' x 48" (457cm x 122cm)	3736	14141	1	2	3	4
	16' x 42" (488cm x 107cm)	3754	14209	1	2	3	4
	16' x 48" (488cm x 122cm)	4273	16173	2	3	3	4
	16' x 52" (488cm x 132cm)	4614	17464	2	3	4	6
	18' x 42" (549cm x 107cm)	4786	18115	2	3	4	6
	18' x 48" (549cm x 122cm)	5455	20647	2	3	4	6
CIRCULAR METAL FRAME POOL	15' x 36" (457cm x 91cm)	3282	12422	1	2	3	4
	15' x 42" (457cm x 107cm)	3861	14614	1	2	3	4
	15' x 48" (457cm x 122cm)	4440	16805	2	3	4	6
	16' x 48" (488cm x 122cm)	5061	19156	2	3	4	6
	18' x 48" (549cm x 122cm)	6423	24311	3	4	5	6
	21' x 52" (640cm x 132cm)	9533	36082	4	5	6	8
	24' x 52" (732cm x 132cm)	12481	47241	6	6	7	8
ULTRA FRAME® POOL	16' x 48" (488cm x 122cm)	5061	19156	2	3	4	6
	18' x 48" (549cm x 122cm)	6423	24311	3	4	4	6
	18' x 52" (549cm x 132cm)	6981	26423	3	4	5	6
	20' x 48" (610cm x 122cm)	7947	30079	3	4	5	6
	22' x 52" (671cm x 132cm)	10472	39637	5	5	6	8
	24' x 52" (732cm x 132cm)	12481	47241	5	6	7	8
	26' x 52" (792cm x 132cm)	14667	55515	7	7	8	12
GRAPHITE GRAY PANEL POOL SET™	15'8" x 49" (478cm x 124cm)	4440	16805	2	3	4	6
	16'8" x 49" (508cm x 124cm)	5061	19156	2	3	4	6
	18'8" x 53" (569cm x 135cm)	6981	26423	3	4	5	6
OVAL FRAME POOL	18' x 10' x 42" (549cm x 305cm x 107cm)	2885	10920	1	2	3	4
	20' x 12' x 48" (610cm x 366cm x 122cm)	4393	16628	2	3	3	4
RECT. ULTRA FRAME POOL	15' x 9' x 48" (457cm x 274cm x 122cm)	3484	13187	1	2	3	4
	18' x 9' x 52" (549cm x 274cm x 132cm)	4545	17203	2	3	4	6
	20 x 10' x 52" (610cm x 305cm x 132cm)	5835	22085	2	3	4	6
	24' x 12' x 52" (732cm x 366cm x 132cm)	8403	31805	4	4	5	6
	32' x 16' x 52" (975cm x 488cm x 132cm)	14364	54368	6	7	8	12

IMPORTANT

The filter pump running time should be 1 hour longer than the required operating time of the Saltwater System.

SALT CALCULATION FORMULA FOR ALL POOLS

Salt Needed for Startup (Lbs)	Salt Needed for Startup (Kgs)	Salt Needed when Low Salt Detected (Lbs)	Salt Needed when Low Salt Detected (Kgs)
Water Capacity (Gals) x 0.025	Water Capacity (Liters) x 0.003	Water Capacity (Gals) x 0.0067	Water Capacity (Liters) x 0.0008

SALT TABLE FOR COMMON NON-INTEX POOLS

Water Capacity		Salt Needed for Startup		Salt Needed when Low Salt Detected (CODE "91")	
(Gals)	(Liters)	(Lbs)	(Kgs)	(Lbs)	(Kgs)
2000	7500	50	20	10	5
4000	15000	100	45	25	10
6000	22500	150	65	40	20
8000	30000	200	90	55	25
10000	37500	250	110	70	30
12000	45500	300	135	80	35
14000	53000	350	160	95	45

CYANURIC ACID TABLE FOR COMMON NON-INTEX POOLS

Water Capacity		Cyanuric Acid Needed for Startup 0.03g/L (30ppm)	
(Gals)	(Liters)	(Lbs)	(Kgs)
2000	7500	0.5	0.23
4000	15000	1.0	0.45
6000	22500	1.5	0.68
8000	30000	2.0	0.90
10000	37500	2.5	1.13
12000	45500	3.0	1.37
14000	53000	3.5	1.59

OPERATING TIME TABLE FOR COMMON NON-INTEX POOLS (WITH CYANURIC ACID)

Water Capacity		Operating Time (hours) at different ambient/air temperatures					
(Gals)	(Liters)	ECO5220/5230			ECO6220/6230		
		10 - 19°C (50 - 66°F)	20 - 28°C (68 - 82°F)	29 - 36°C (84 - 97°F)	10 - 19°C (50 - 66°F)	20 - 28°C (68 - 82°F)	29 - 36°C (84 - 97°F)
2000	7500	2	3	4	1	1	2
4000	15000	4	5	6	1	2	3
6000	22500	6	7	8	2	3	4
8000	30000	-	-	-	3	4	5
10000	37500	-	-	-	4	5	6
12000	45500	-	-	-	5	6	7
14000	53000	-	-	-	6	7	8

OPERATION INSTRUCTIONS



1. Turn on the filter pump.

2. Start up the unit:

Plug the power cord into the electrical outlet and test the RCD (circuit breaker). Press  button. Flashing code "00" appears on the electronic control station's LED, indicating that the unit is ready to be programmed.



3. Set operating hours for Saltwater system:

With code "00" flashing, press  button to set the desired operating hours. See the "Operating Time Table" for the required operating hours related to each pool size. Pressing  will increase the time from 01 to 12 hours maximum. If you have selected too many hours keep pressing  to repeat the cycle. The built-in timer will now activate your Saltwater System, at the same time each day, for the number of hours you have set.



(1 to 12 hours max per cycle)

NOTE: The Saltwater System will not operate if the filter pump is not operating. Make sure to program your filter pump (or start it manually) for operation beginning 5 minutes before the saltwater system and finishing 15 minutes after the saltwater system.

4. Lock keypad controls:

With the desired hour value showing, press  button until you hear a "beep". A green "WORKING" indicator on the control panel will light up within a few seconds to indicate that the saltwater system has started chlorine production. Locking the control buttons into this setting prevents unauthorized changing of the operating cycle.

NOTE: If you forget to lock the keypad controls, the system will automatically lock it and start working 1 minute later.



5. Readjust operating time if necessary:

The operating hours can be re-adjusted if necessary. Press  button until you hear a "beep" to unlock the keypad and the current programmed time will flash. Repeat steps 3 to 4.



OPERATION INSTRUCTIONS (continued)

6. Boost cycle

- First time installation, press and hold "BOOST" button for 5 seconds until the indicator lights up and the LED display "80". This indicates that the saltwater system has started more chlorine sanitizer production. You can press and hold the "BOOST" button for another 5 seconds until the indicator is off, which will cancel the Boost cycle.
- The boost operating hours is 8 times the amount of time programmed into the system, i.e. if your saltwater system operating time is 2 hours, the boost procedure will run 8 x 2 = 16 hours. After boost procedure has been completed, the system will automatically switch to the normal working mode.
- Once the boost is operating, check whether the filter pump operating hours have been set properly. For example, the boost operating time is 8 hours, the filter pump should be set to run for 8 hours at least. Increase the filter pump operating time if necessary.

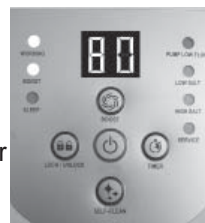

NOTE: If an Intex filter pump is attached to the system, set the pump switch to on "1" position.

- After a heavy rain or if the pool is dirty, press the "BOOST" button to shock the pool again.

7. Stand-by/power saving mode:

- When the cycle ends, the green "SLEEP" indicator on the control panel lights up and the LED display flashes "93". The system is now in Stand-By mode. After a while, it shuts down and sets itself in a Power Saving mode. The system will automatically turn itself back on in 24 hours, starting its daily cycle of chlorine production.
- The "SLEEP" indicator stays on, while the system is in the Power Saving mode. The LED display however, goes blank after 5 minutes. Press any button (or) to view the last LED code.



8. Electrode Self-Clean cycle:

- Press and hold button for 5 seconds until the LED display flashes "10". Depending on your pool water calcium hardness level, press button again to select the self-clean cycle time as below. Total of 3 settings: 14 hours, 10 hours and 06 hours.



Calcium Hardness	Self-clean cycle time
0 - 150 ppm	Reverse polarity every 14 hours
150 - 250 ppm	Reverse polarity every 10 hours
250 - 350 ppm	Reverse polarity every 06 hours

NOTE: The life of the cell varies depending on water conditions, pool usage and operating time of the device. Select 14 hours cycle time to maximize the life of the electrolytic cell if the calcium hardness level is up to 150 ppm. Manual routine cleaning and maintenance will further lengthen the life of the electrolytic cell.

- With the desired self-clean hours showing, press button to lock the keypad controls and the LED display will return to the normal operating time. The system will reverse the polarity of the electrode (5) every time according to the selected hours.

NOTE: If you forget to lock the keypad controls, the system will automatically lock it.

LED CODE CHART

LED Reading	Definitions
80	Boost Mode
00	Stand-By Mode (Start-up)
01	Minimum Operating Hour (1 hour remaining)
02	Operating Hours (2 hours remaining)
03	Operating Hours (3 hours remaining)
04	Operating Hours (4 hours remaining)
05	Operating Hours (5 hours remaining)
06	Operating Hours (6 hours remaining)
07	Operating Hours (7 hours remaining)
08	Operating Hours (8 hours remaining)
09	Operating Hours (9 hours remaining)
10	Operating Hours (10 hours remaining)
11	Operating Hours (11 hours remaining)
12	Maximum Operating Hours (12 hours remaining)
90	Alarm Code (Low Pump Flow / No Flow)
91	Alarm Code (Low Salt Level)
92	Alarm Code (High Salt Level)
93	Stand-By Mode (Operating Process finished)
"BLANK"	No Power or "Power Saving Mode" waiting to start next Saltwater System cycle.

IMPORTANT

When Code "90" alarm is shown, ensure the timer of the filter pump is set one (1) hour longer than the Saltwater System.

If the filter pump does not have a built-in timer, the filter pump needs to be turned on/off manually every day.

SALTWATER SYSTEM STATIONARY MOUNTING

Some countries, especially in the European community, require the product to be secured to the ground or to a base in a permanent upright position. Check with your local authorities to determine if there is a regulation in your area regarding above-the-ground swimming pool filter pumps. If yes, then the product can be mounted to a platform using the two holes located in the base. See drawing below.

The product can be mounted on a cement base or onto a wooden platform to prevent accidental tipping. Total assembly must exceed 18kg .

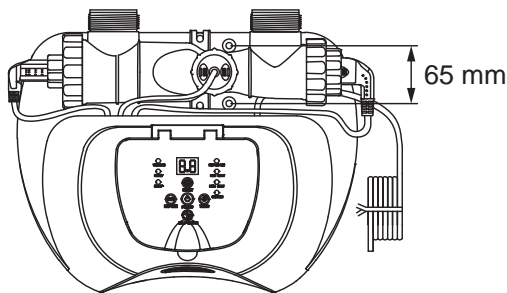

Model ECO5220/5230

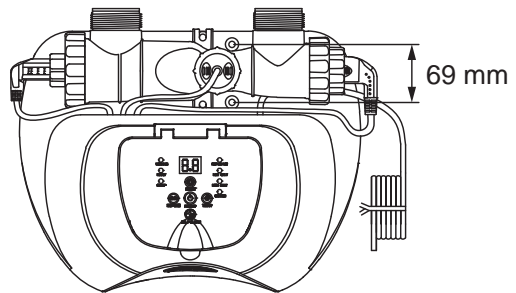

Model ECO6220/6230

- 1. For model ECO5220/5230:** The mounting holes are 6.4 mm in diameter and spaced 65 mm apart.
For model ECO6220/6230: The mounting holes are 6.4 mm in diameter and spaced 69 mm apart.
- 2. Use two bolts and lock nuts with a maximum of 6.4 mm in diameter.**

MAINTENANCE

IMPORTANT

Unplug the power cord before cleaning your system. Also close the plunger valves on your pool or insert the black hat-like plugs in the strainer opening to prevent water spillage. After completing all maintenance tasks, you must plug the power cord back in and open the plunger valves or remove the plugs.

Flow Sensor Cleaning

1. In a counter-clockwise motion unscrew the collar of the flow sensor (6) and remove it from the electrolytic cell conduit. See "Part Reference".
2. If deposits and debris are seen on the surface of the flow sensor, then use a garden hose to wash it off.



3. If flushing with water does not remove the deposits, use a plastic brush to clean the surface and the hinge if necessary. Do not use a metal brush.
4. After the flow sensor has been inspected and cleaned, align the locator notch on the flow sensor to the connection ridge in the conduit. Now turn the collar in a clockwise motion, tightening the sensor back into its position. Do not overtighten.

Electrodes Cleaning

The electrodes have a self cleaning function incorporated into the electronic control's programming. In most cases this self cleaning action will keep the electrodes working at optimum efficiency. If the pool water is hard (high mineral content) the electrodes may require periodic manual cleaning. To maintain maximum performance, we recommend that you open and visually inspect the primary and secondary electrodes (5 & 4) monthly.

The following steps provide instructions on how to clean your cell.

Inspection and cleaning:

1. Switch off the unit, unplug the power cord from the electrical socket.
2. **For filter pumps with 1-1/4" (32mm) hose size** - To prevent water from flowing out of the pool, unscrew the strainer grids from the strainer connectors and insert the hat-like plugs into the strainer connectors.

For filter pumps with 1-1/2" (38mm) hose size - Turn both plunger valve handles fully clockwise until they stop. This closes the valve, prevents the water from flowing out of the pool.

MAINTENANCE (continued)

3. Disconnect the 2 hoses from the Saltwater System, and attach the cell covers (9) to the inlet and outlet of the electrolytic cell (3).

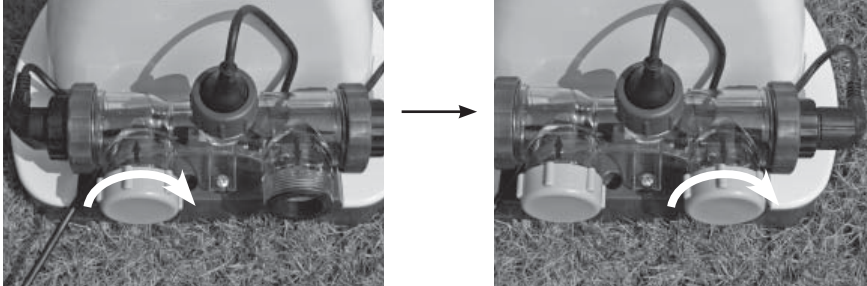

4. Unscrew the collar of the flow sensor (6) and pull out the flow sensor from the electrolytic cell (3) housing.

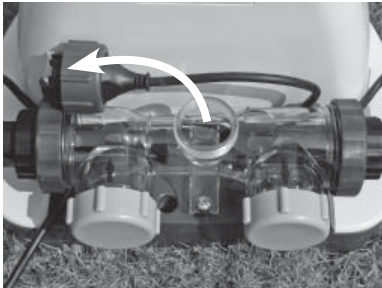

5. Pour kitchen grade vinegar into the electrolytic cell housing (3) to immerse the electrodes. Soak for 1 hour.



6. Open one side of the cell cover (9), drain and properly dispose of the vinegar. Connect the hose which goes from the pool to the cell. Flush the electrolytic cell housing with the pool water.



7. Reverse steps 3, 4, 5 and 6 to reconnect the electrolytic cell.

MAINTENANCE (continued)

INTEX® TEST STRIPS (PACKED WITH THE PRODUCT)

The Test Strips can test the "Free Chlorine", "pH", "Calcium Hardness" and "Total Alkalinity" levels at the same time. We recommend that you test the water chemistry weekly, and maintain the chlorine concentration at 0.5-3.0 ppm.

Directions and Use

1. Dip the entire strip into the water and remove immediately.
2. Hold the strip level for 15 seconds. Do not shake excess water from the strip.
3. Now compare the strip pad to the color chart on the packaging label. If necessary, adjust the chemical level in the pool water. It is very important, to use the proper technique when testing the water's chemical level. Read and follow the written strip instructions carefully.

LONG TERM STORAGE

1. Disconnect the power cord from the electrical outlet.
2. After the pool is completely empty, disconnect the Saltwater System from the hoses by reversing the installation instructions.
3. Air-dry the unit before you store it. This might be a good time to visually inspect and clean the electrolytic cell.
4. Store the unit and accessories in a dry place. The temperature should be controlled, between 32 degrees Fahrenheit (0 degrees Celsius) and 97 degrees Fahrenheit (36 degrees Celsius).
5. The original package can be used for storage.

POOL MAINTENANCE & CHEMICAL DEFINITIONS

Preferred Water Chemistry Reading			
	Minimum	Ideal	Maximum
Free Chlorine	0	0.5 - 3.0 ppm	5.0 ppm
Combined Chlorine	0	0 ppm	0.2 ppm
pH	7.2	7.4 - 7.6	7.8
Total Alkalinity	40 ppm	80 ppm	120 ppm
Calcium Hardness	50 ppm	100 - 250 ppm	350 ppm
Stabilizer (Cyanuric Acid)	10 ppm	20 - 40 ppm	50 ppm

Consult with local swimming pool dealer for water treatment.





Free Chlorine	- Is the chlorine residual present in pool water.
Combined Chlorine	- Is formed by the reaction of free chlorine with ammonia wastes. Result if too high - Sharp chlorinous odor, eye irritation.
pH	- A value that indicates how acidic or basic a solution is. Result if too low - Corroded metals, eye & skin irritation, destruction of total alkalinity. Result if too high - Scale formation, cloudy water, shorter filter runs, eye & skin irritation, poor chlorine efficiency.
Total Alkalinity	- Indicates the degree of the water's resistance to change in pH. It determines the speed and ease of pH change, so always adjust total alkalinity before adjusting the pH level. Result if too low - Corroded metals, eye & skin irritation. Low alkalinity will cause the pH to be unstable. Any chemical added to the water will have an affect on pH. Result if too high - Scale formation, cloudy water, eye & skin irritation, poor chlorine efficiency.
Calcium Hardness	- Refers to the amount of calcium and magnesium dissolved in the water. Result if too high - Eye & skin irritation, difficulty balancing water and poor chlorine efficiency. Scale will form and will cause the water to become cloudy.
Stabilizer (Cyanuric Acid)	- Stabilizers extend the life of chlorine in swimming pools.

- Do not add pool chemicals directly to the skimmer. This may damage the cell.
- Maintaining a salt and sanitizer level above the recommended range can contribute to the corrosion of the pool equipment.
- Check the expiry date of the test kit as the test results may be inaccurate if the kit is used after that date.
- If, due to heavy pool usage, it is required to increase the sanitizer level, then use a chemical based on trichlor, TCCA or dichloro.

TROUBLESHOOTING GUIDE

PROBLEM	CAUSE	SOLUTION
INSUFFICIENT CHLORINE	<ul style="list-style-type: none"> • Insufficient operating hours of the Saltwater System. • The salt level in the pool water is less than 2000ppm. This is insufficient. • Chlorine loss due to intense sunlight exposure. • The bather load has increased. • Clogged or dirty electrolytic cell. • High UV level exposure. 	<ul style="list-style-type: none"> • Increase the daily Saltwater System operating time. See "Operating Instructions". • Check the salt level with the Test Kit. Adjust as needed. See "Salt & Pool Water Volumes". • Use a pool cover when the pool is not in use and/or when the unit is operating. • Increase the daily Saltwater System operating time. See "Operating Instructions". • Remove the cell for inspection, clean it if necessary. See "Maintenance". • Cover the pool with a pool cover for 2 days with the device running and then test the water using the test strips. • If the pool is clean and clear, add stabilizer to the water and then test the water with the device running.
WHITE FLAKES IN THE WATER	<ul style="list-style-type: none"> • Excessive calcium hardness is present in pool water. 	<ul style="list-style-type: none"> • Drain about 20 to 25% of the pool water and add fresh water to decrease the calcium hardness. Inspect the electrolytic cell for scale buildup. Clean the electrolytic cell if necessary.
NO LED DISPLAY	<ul style="list-style-type: none"> • No power supply. • RCD has not reseted. • A power fuse has blown. • LED failure. 	<ul style="list-style-type: none"> • Find out the switch and turn on. • Reset the RCD. • Contact Intex Service Center.

TROUBLESHOOTING GUIDE (continued)

LED PANEL CODE	PROBLEM	SOLUTION
LED Panel Code Flash & Alarm On (NOTE: Always turn off the power before cleaning and servicing).		
	1. Filter pump not attached to system and/or switch on.	<ul style="list-style-type: none"> • Ensure filter pump is attached and operating. See "Setup Instruction".
	2. Circulation line is blocked.	<ul style="list-style-type: none"> • If your unit has plunger valves, ensure that they are open. • Clear your filter cartridge and cell from debris and dirt. See "Maintenance". • Release all trapped air in the circulation line. See the filter pump manual.
	3. Incorrect inlet and outlet hose direction.	<ul style="list-style-type: none"> • Check the direction of the inlet and the outlet hose. Reverse the hoses if necessary. See "Set Up Instructions".
	4. Scale on the flow sensor.	<ul style="list-style-type: none"> • Clean the flow sensor, paying special attention to the hinge. See "Maintenance".
	5. Flow sensor cord is loose.	<ul style="list-style-type: none"> • Plug the flow sensor firmly into the flow sensor receptacle.
	6. Inner timer conflict between filter pump and saltwater system.	<ul style="list-style-type: none"> • Reset both timers on the filter pump and saltwater system. See "Boost Cycle".
	7. Flow sensor failure.	<ul style="list-style-type: none"> • Contact Intex Service Center.
	1. Dirt or scale on titanium plates.	<ul style="list-style-type: none"> • Remove primary electrolytic cell for inspection. Clean it if necessary. See "Maintenance".
	2. Low salt level / No salt.	<ul style="list-style-type: none"> • Add salt. See "Salt & Pool Water Volumes".
	3. Electrolytic cell cord is loose.	<ul style="list-style-type: none"> • Ensure that the cell cord is plugged firmly into the cell housing receptacle.
	4. Possible electrolytic cell failure.	<ul style="list-style-type: none"> • Contact Intex Service Center. Replace the cell if needed.
	1. High salt level.	<ul style="list-style-type: none"> • Partially drain the pool and refill it with fresh water. See "Salt & Pool Water Volumes".
	<ol style="list-style-type: none"> 1. LED display is off and the "SERVICE" light is on - the system does not power up. 2. Caused by high humidity. 3. PCB failure. 	<ul style="list-style-type: none"> • Household voltage is too high or too low ($\pm 20\%$). Check the voltage is within the range stated on the device housing. • Run the system during midday and avoid running it during dawn, foggy or raining time. Place a piece of tile or similar pad, 15"x15" (38x38 cm) in size, between the device and the ground to keep ground water evaporation away from the system. • Contact Intex Service Center.

IMPORTANT

If you continue to experience difficulty, please contact our Consumer Service Department for assistance. See separate "Authorized Service Centers" sheet.

CONTROL STATION REPLACEMENT

Tools required: One (1) Phillips screwdriver

If only the control station **(13)** needs to be replaced as instructed by the service center, remove all the components inside the dotted frame and keep them in a safe place for later use.

Once you have received the new replacement control station, reinstall all the components from the previous unit to the new control station.

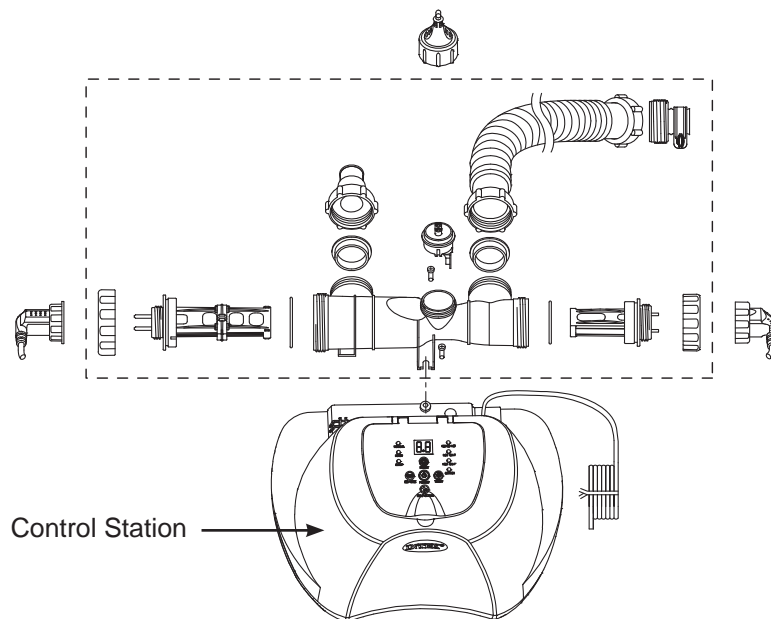

GENERAL AQUATIC SAFETY

Water recreation is both fun and therapeutic. However, it involves inherent risks of injury and death. To reduce your risk of injury, read and follow all product, package and package insert warnings and instructions. Remember, however, that product warnings, instructions and safety guidelines cover some common risks of water recreation, but do not cover all risks and dangers.

For additional safeguards, also familiarize yourself with the following general guidelines as well as guidelines provided by nationally recognized Safety Organizations:

- Demand constant supervision. A competent adult should be appointed as a "lifeguard" or water watcher, especially when children are in and around the pool.
- Learn to swim.
- Take the time to learn CPR and first aid.
- Instruct anyone who is supervising pool users about potential pool hazards and about the use of protective devices such as locked doors, barriers, etc.
- Instruct all pool users, including children what to do in case of an emergency.
- Always use common sense and good judgement when enjoying any water activity.
- Supervise, supervise, supervise.

LIMITED WARRANTY

Your Krystal Clear™ Saltwater System has been manufactured using the highest quality materials and workmanship. All Intex products have been inspected and found free of defects prior to leaving the factory. This limited warranty applies only to the Krystal Clear™ Saltwater System and accessories listed below.

This limited warranty is in addition to, and not a substitute for, your legal rights and remedies. To the extent that this warranty is inconsistent with any of your legal rights, they take priority. For example, consumer laws across the European Union provide statutory warranty rights in addition to the coverage you receive from this limited warranty: for information on EU-wide consumer laws, please visit the European Consumer Center website at http://ec.europa.eu/consumers/ecc/contact_en/htm.

The provisions of this limited warranty apply only to the original purchaser and are not transferable. This limited warranty is valid for the period noted below from the date of the initial retail purchase. Keep your original sales receipt with this document, as proof of purchase will be required and must accompany warranty claims or the limited warranty will be invalid.

Krystal Clear™ Saltwater System Warranty – 2 Years

Electrolytic cells Warranty – 1 Year

Hoses, Plunger Valves & Fittings Warranty – 180 days

If you find a manufacturing defect in the Krystal Clear™ Saltwater System during the warranty periods noted above, please contact the appropriate Intex Service Center listed in the separate "Authorized Service Centers" sheet. If the item is returned as directed by the Intex Service Center, the Service Center will inspect the item and determine the validity of the claim. If the item is covered by the provisions of the warranty, the item will be repaired or replaced, with the same or comparable item (at Intex's choice) at no charge to you.

Other than this warranty, and other legal rights in your country, no further warranties are implied. To the extent possibly in your country, in no event shall Intex be liable to you or any third party for direct or consequential damages arising out of the use of your Krystal Clear™ Saltwater System, or Intex or its agents' and employees' actions (including the manufacture of the product). If your country does not allow the exclusion or limitation of incidental or consequential damages, this limitation or exclusion does not apply to you.

You should note that this limited warranty does not apply in the following circumstances:

- If the Krystal Clear™ Saltwater System is subject to negligence, abnormal use or application, accident, improper operation, improper voltage or current contrary to operating instructions, improper maintenance or storage;
- If the Krystal Clear™ Saltwater System is subject to damage by circumstances beyond Intex's control, including but not limited to, ordinary wear and tear and damage caused by exposure to fire, flood, freezing, rain, or other external environmental forces;
- To parts and components not sold by Intex; and/or
- To unauthorized alterations, repairs or disassembly to the Krystal Clear™ Saltwater System by anyone other than Intex Service Center personnel.

The costs associated with the loss of pool water, chemicals or water damages are not covered by this warranty. Injury or damage to any property or person is not covered by this warranty.

Read the owner's manual carefully and follow all instructions regarding proper operation and maintenance of your Krystal Clear™ Saltwater System. Always inspect your product prior to use. This limited warranty will be void if use instructions are not followed.



INTEX

Don't forget to try these other fine Intex products:
Pools, Pool Accessories, Inflatable Pools and
In-Home Toys, Airbeds and Boats available at fine
retailers or visit our website.

©2018 Intex Marketing Ltd. - Intex Development Co. Ltd. -
Intex Recreation Corp.

All rights reserved/Tous droits réservés/Todos los
derechos reservados/Alle Rechte vorbehalten. Printed in
China/Imprimé en Chine/Impreso en China/Gedruckt in
China.

®™ Trademarks used in some countries of the world under
license from/®™ Marques utilisées dans certains pays sous
licence de/Marcas registradas utilizadas en algunos países del
mundo bajo licencia de/Warenzeichen verwendet in einigen
Ländern der Welt in Lizenz von/Intex Marketing Ltd. to/à/a/an
Intex Development Co. Ltd., G.P.O Box 28829, Hong Kong
& Intex Recreation Corp., P.O. Box 1440, Long Beach, CA
90801 • Distributed in the European Union by/Distribué dans
l'Union Européenne par/Distribuido en la unión Europea por/
Vertrieb in der Europäischen Union durch/Intex Trading B.V.,
Venneveld 9, 4705 RR Roosendaal – The Netherlands
www.intexcorp.com

