



SAND FILTER & SALTWATER COMBO PUMP #CS20220

(Product Code: 56682)



10255

#10255

Flat Strainer Rubber Washer
PLU# 32937



10460

#10460

Air Release Valve
PLU# 32929



#10747

Plunger Valve
PLU# 29201



#10256

Strainer Nut
PLU# 32936



#10722

Adaptor B
PLU# 32940



#11010

3M Hose with Nuts
PLU# 37540

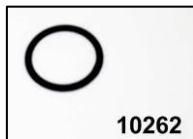

10262

#10262

Hose O-Ring
PLU# 32934



#10744

Threaded Strainer Connector
PLU# 37494



#11070

Strainer Connector
PLU# 29208

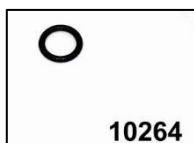

10264

#10264

Air Release Valve O-Ring
PLU# 32930



#10745

Step Washer
PLU# 32935



#11071

Pool Inlet Nozzle
PLU# 29209

SAND FILTER & SALTWATER COMBO PUMP #CS20220 cont.



#11072
Strainer Grid
PLU# 30042



#11232
Leaf Trap O-Ring
PLU# 37564



#11372
Electrolytic Cell Housing
PLU# 37574



#11074
Adjustable Pool Inlet Nozzle
PLU# 32939



#11234
Copper Electrode
PLU# 37566



#11374
Titanium Electrode
PLU# 37575



#11131
Electrolytic Cell Cover
PLU# 37554



#11260
Basket
PLU# 37569



#11379
Tank O-Ring
PLU# 37577



#11224
Pressure Gauge
PLU# 37561



#11261
Filter Housing Nut
PLU# 37570



#11380
Clamp Bolt
PLU# 37578



#11228
L-Shape O-Ring
PLU# 37562



#11371
Pre-Filter Assembly
PLU# 37573



#11381
Screw
PLU# 37579

SAND FILTER & SALTWATER COMBO PUMP #CS20220 cont.

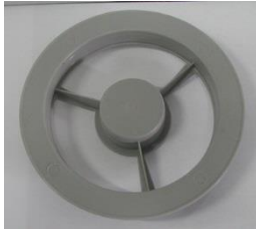

#11382
Sand Shield
PLU# 37580



#11479
Leaf Trap Nut
PLU# 37613

PLU# 37618



#11515
O-Ring on Titanium Plates
PLU# 37623



#11384
Lateral
PLU# 37582



#11480
Leaf Trap Cover
PLU# 37614



#11464AU
220-240V Pump/Motor
PLU# 37609



#11385
Washer
PLU# 37583



#11488
Copper Electrode Nut
PLU# 37615



#11514
Tank Base
PLU# 37622



#11456
Drain Valve Cap
PLU# 37606



#11495
Centre Pipe Hub
PLU# 37617



#11536
Interconnecting Hose
PLU# 37626



#11460
Flow Sensor
PLU# 37608



#11496
6-Way Valve

SAND FILTER & SALTWATER COMBO PUMP #CS20220 cont.

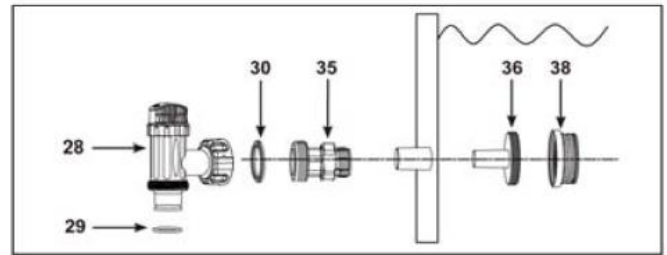
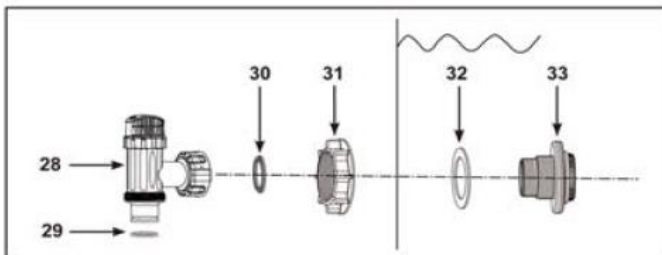
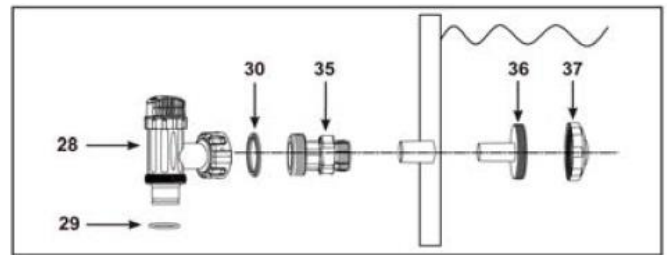
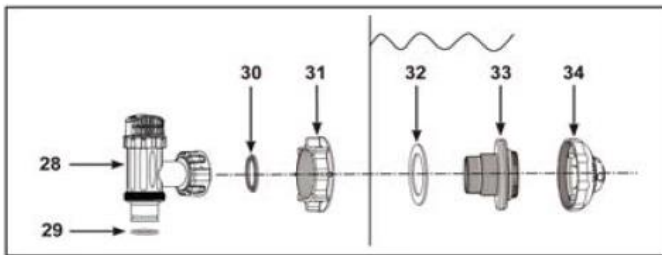
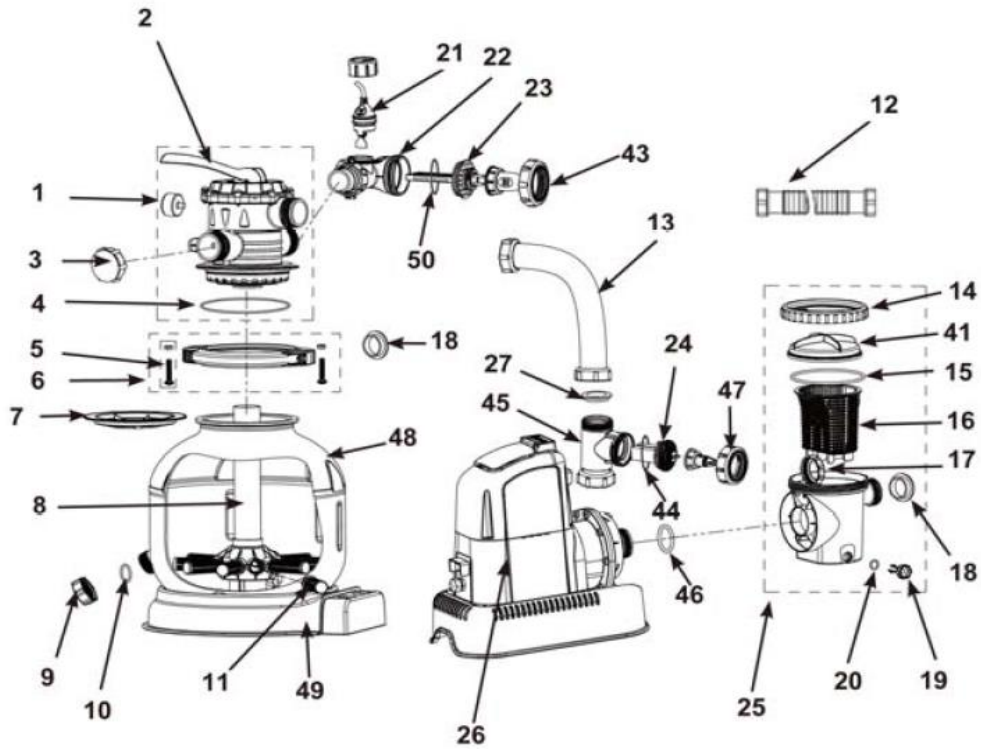

SAND FILTER & SALTWATER COMBO PUMP #CS20220 cont.

REF NO.	PLU#	SPARE PART NO.	DESCRIPTION	QTY
1	37561	11224	PRESSURE GUAGE	1
2	37618	11496	6-WAY VALVE	1
3	37554	11131	DRAIN OUTLET COVER	1
4	37577	11379	TANK O-RING	1
5	37579	11381	SCREW	2
6	37578	11380	CLAMP WITH SCREWS	1
7	37580	11382	SAND SHIELD	1
8	37617	11495	CENTRE PIPE HUB	1
9	37606	11456	DRAIN VALVE CAP	1
10	37583	11385	DRAIN VALVE O-RING	1
11	37582	11384	LATERAL	10
12	37540	11010	HOSE WITH NUTS	2
13	37626	11536	INTERCONNECTING HOSE	1
14	37613	11479	LEAF TRAP NUT	1
15	37564	11232	LEAF TRAP O-RING	1
16	37569	11260	BASKET	1
17	37570	11261	FILTER HOUSING NUT	1
18	37562	11228	L-SHAPE O-RING	4
19	32929	10460	SEDIMENT RELEASE VALVE	1
20	32930	10264	VALVE O-RING	1
21	37608	11460	FLOW SENSOR	1
22	37574	11372	ELECTROLYTIC CELL HOUSING	1
23	37575	11374	TITANIUM PLATES	1
24	37566	11234	COPPER ELECTRODE	1
25	37573	11371	PRE-FILTER ASSEMBLY	1
26	37609	11464	PUMP AND MOTOR HOUSING	1
27	37594	11439	L-SHAPE O-RING	1
28	29201	10747	PLUNGER VALVE	2
29	32934	10262	HOSE O-RING	2
30	32935	10745	STEP WASHER	2
31	32936	10256	STRAINER NUT	2
32	32937	10255	FLAT STRAINER RUBBER WASHER	2
33	32938	11235	THREADED STRAINER CONNECTOR	2
34	32939	11074	ADJUSTABLE POOL INLET NOZZLE	1
35	32940	10722	ADAPTOR B	2
36	29208	11070	STRAINER CONNECTOR FOR 1-1/4"	2
37	29209	11071	POOL INLET NOZZLE	1
38	30042	11072	STRAINER GRID	1
41	37614	11480	LEAF TRAP COVER	1
43	37592	11432	ELECTROLYTIC CELL NUT	1
44	37595	11440	O-RING FOR COPPER ELECTRODE	1
45	37596	11441	O-RING FOR ELECTRODE HOUSING	1
46	37607	11457	O-RING FOR MOTOR INLET	2
47	37615	11488	COPPER ELECTRODE NUT	1
48	37619	11498	TANK	1
49	37621	11513	TANK BASE	1
50	37623	11515	O-RING ON TITANIUM PLATES	1